

CATALOGUE

PIECES DE RECHANGES SPECIALES

RENAULT 5 GT TURBO VERSION "COUPE"

6ème EDITION - ANNEE 1990

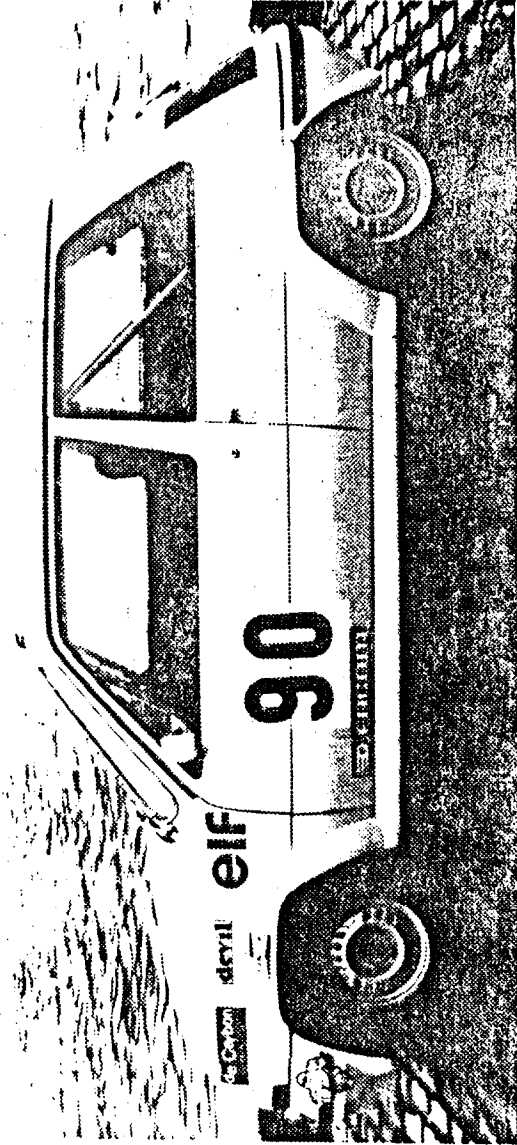

PIECES DE RECHANGE SPECIFIQUES

RENAULT 5 GT TURBO "COUPE"

Les pièces marquées d'un * sont disponibles à l'adresse suivante :

SERVICE APRES-VENTE RENAULT ALPINE
ZONE INDUSTRIELLE DE ROUXMESNIL
76370 ROUXMESNIL BOUTEILLES

Tel. (35) 82.93.14 - (35) 82.33.65

Telex : Alpin 180426

Elles peuvent être commandées et livrées chez votre Concessionnaire RENAULT
(dans ce cas, le port est gratuit).

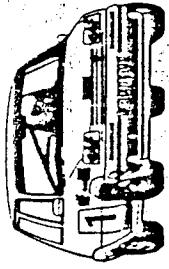

1

1 - 77 00 564 872 *
Repère rouge

2 - 60 01 003 024 *
Repère vert Ø 75,905 à 75,915
Repère bleu Ø 75,915 à 75,925
Repère rouge Ø 75,925 à 75,935

3 - 77 00 502 511

4 - 06 07 777 500

5 - 77 00 583 517 UFLEX
60 01 000 207 GOETZ

6 - 77 00 612 591 *

7 - 77 00 575 994

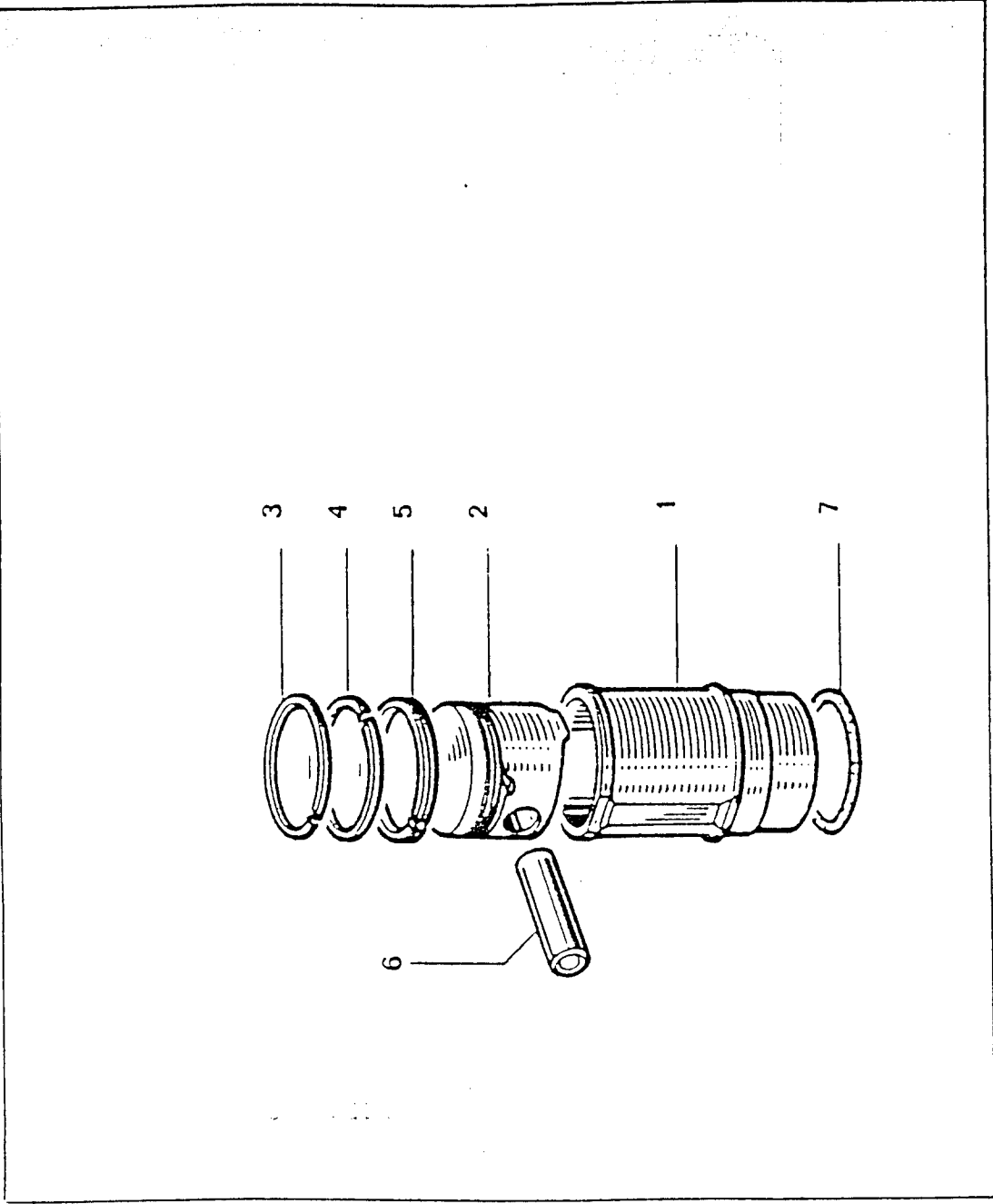

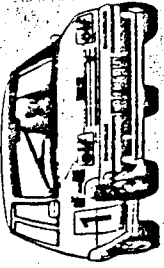

2

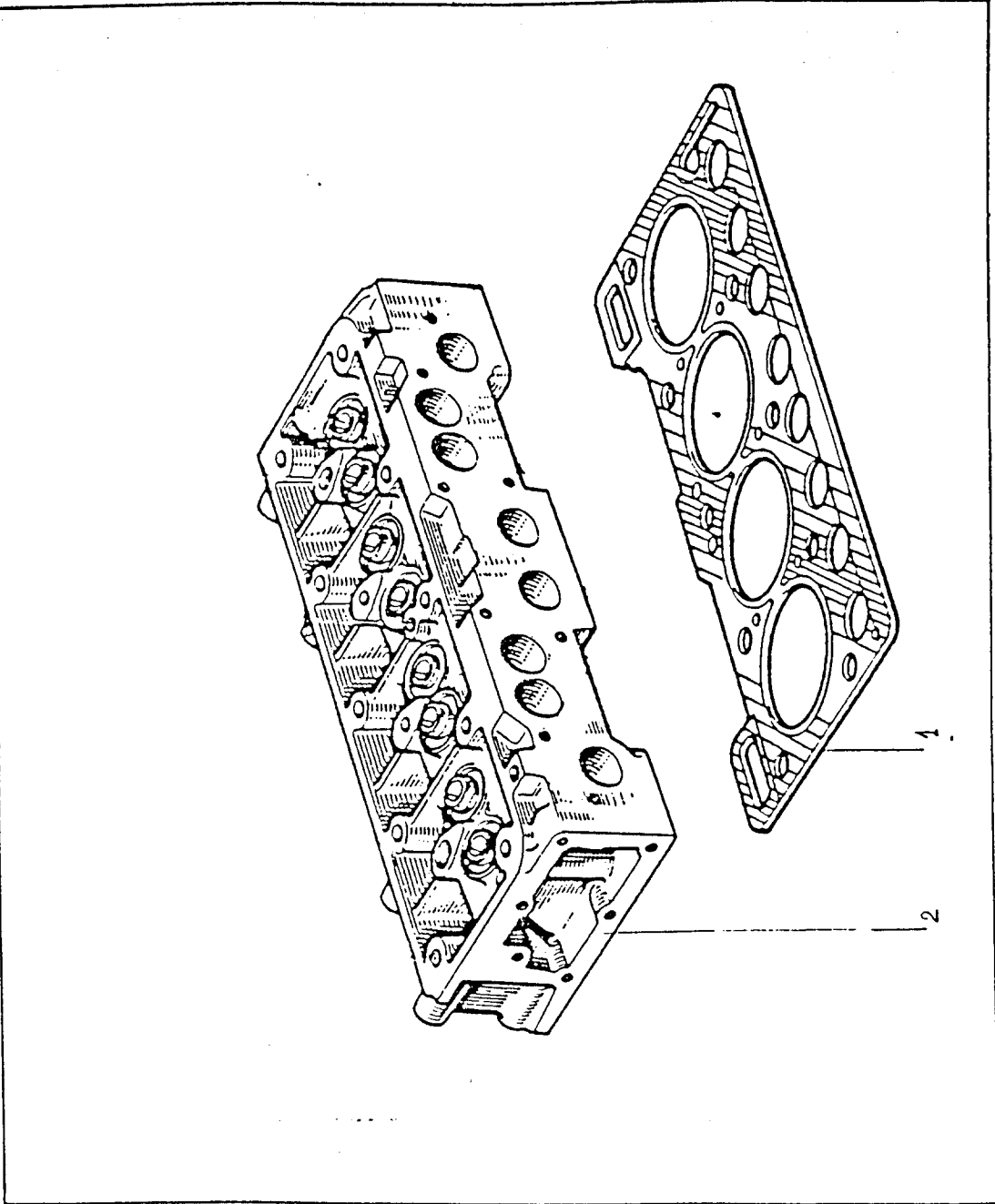

1 - 60 01 006 830 *
(épaisseur 1,80)

Joint de culasse REINZ

2 - 60.01.004.988 *

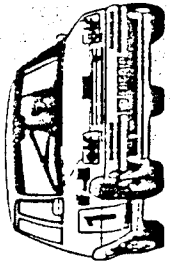

3

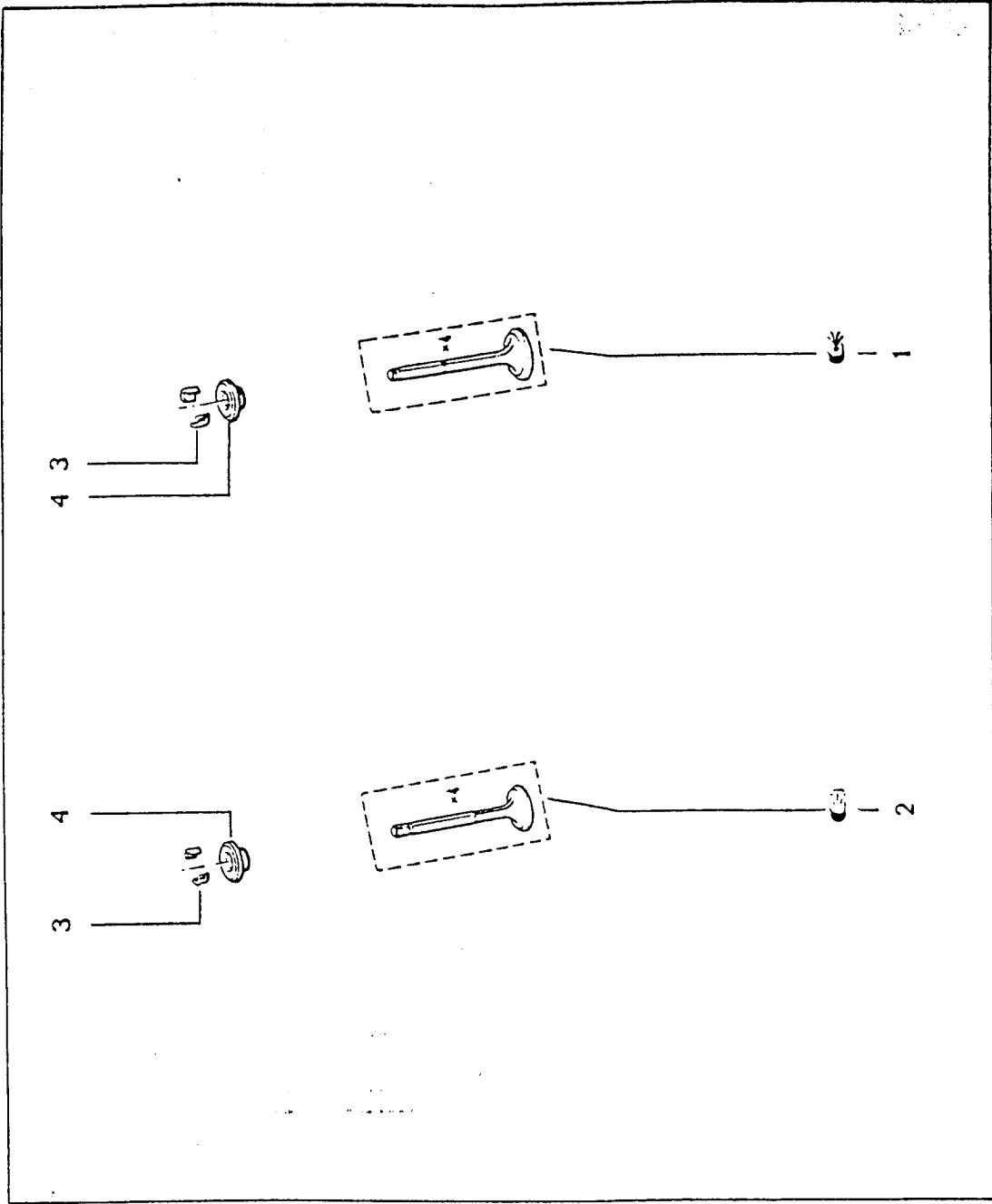

- 1 - 60 01 009 259 *
- 2 - 60 01 009 260 *
- 3 - 77 11 066 739 *
- 4 - 77 11 066 676 *

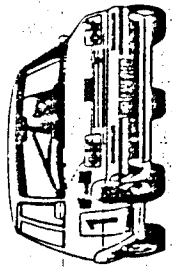

4

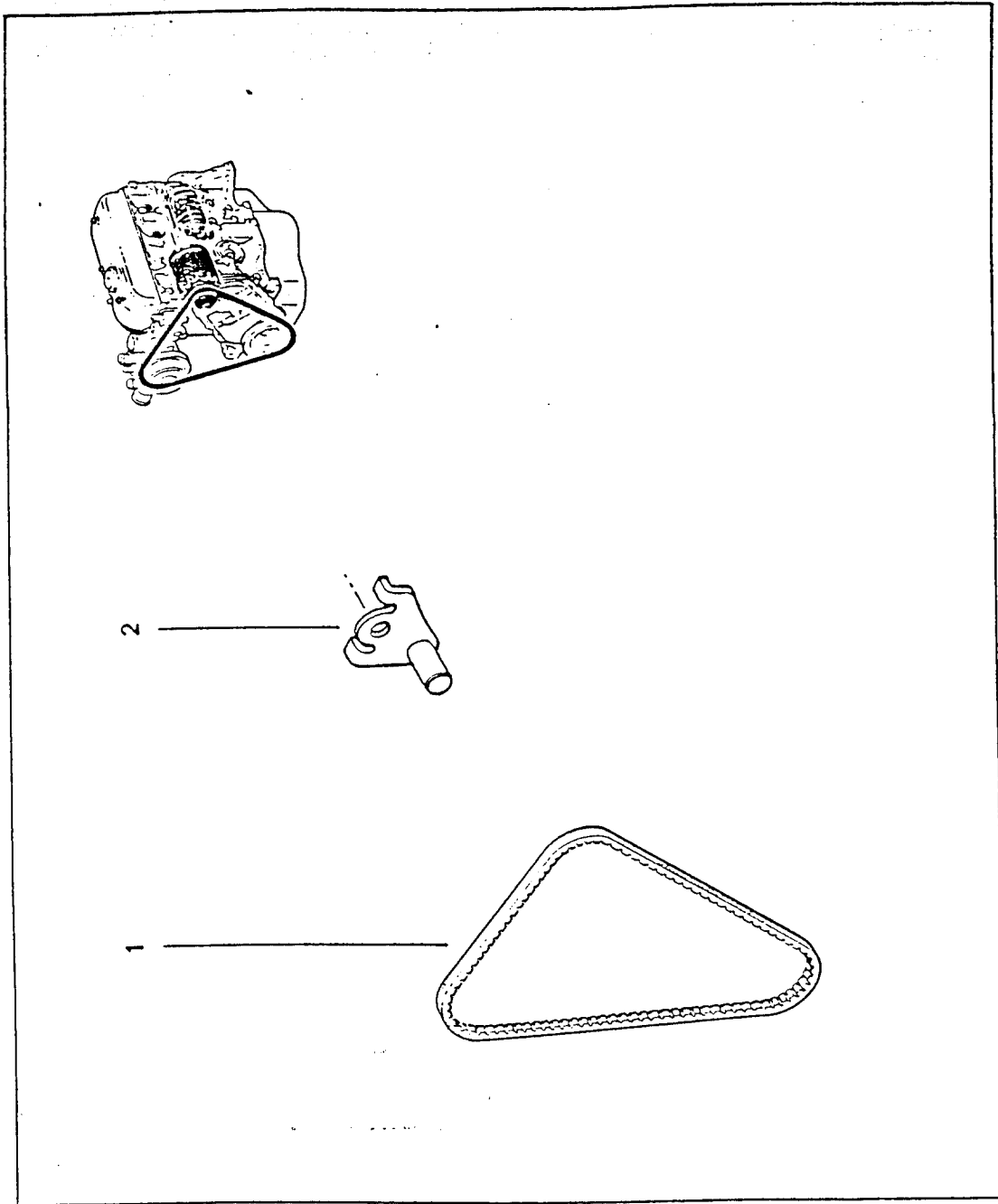

1 - 60 01 006 869 *

2 - 60 01 008 185

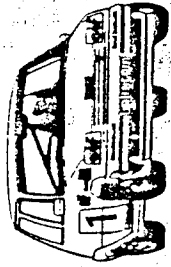

5

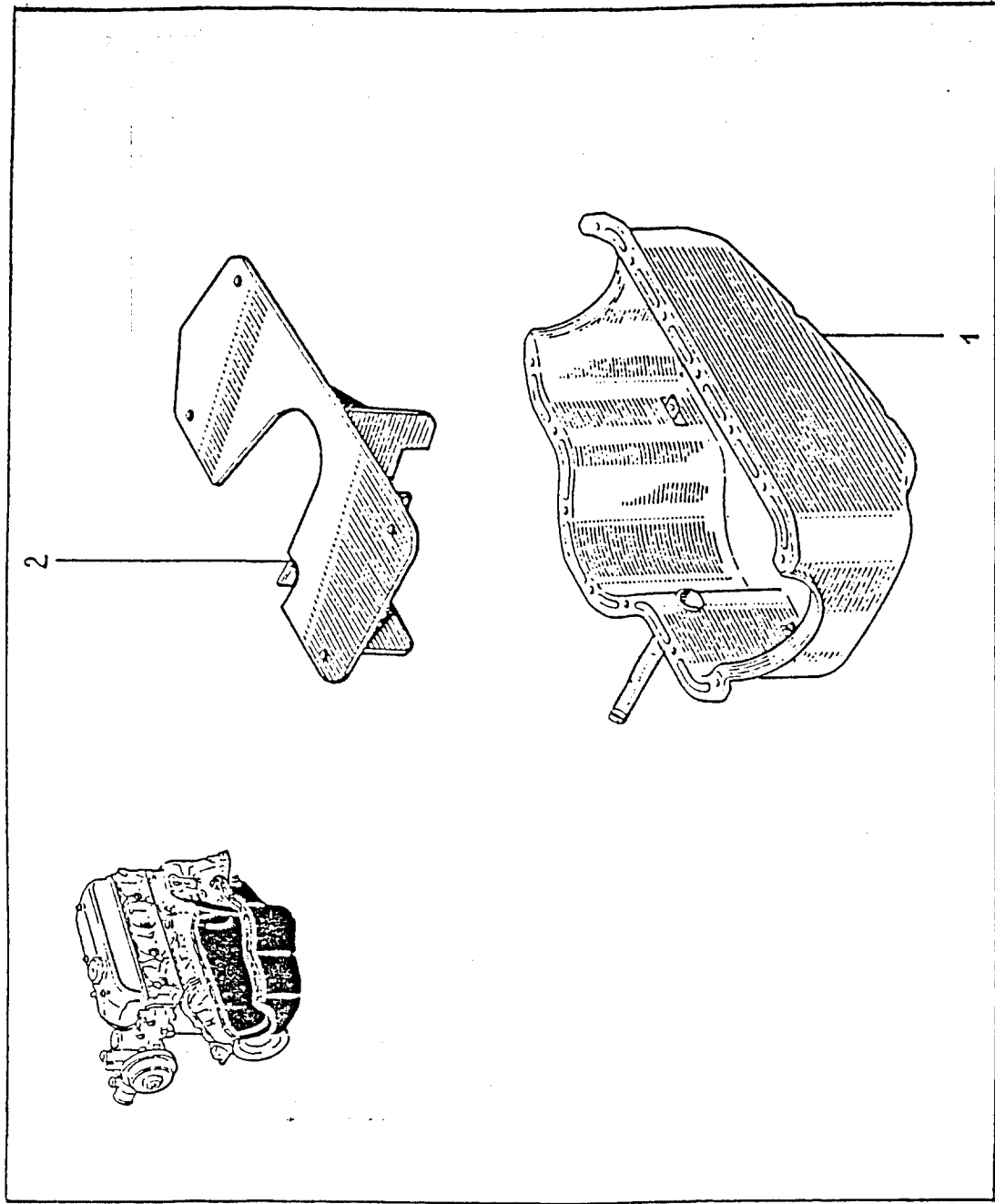

1 - 60 01 006 831 *

2 - 60 01 006 417 *

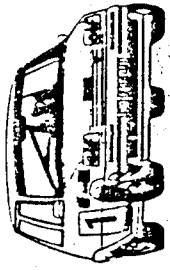

6

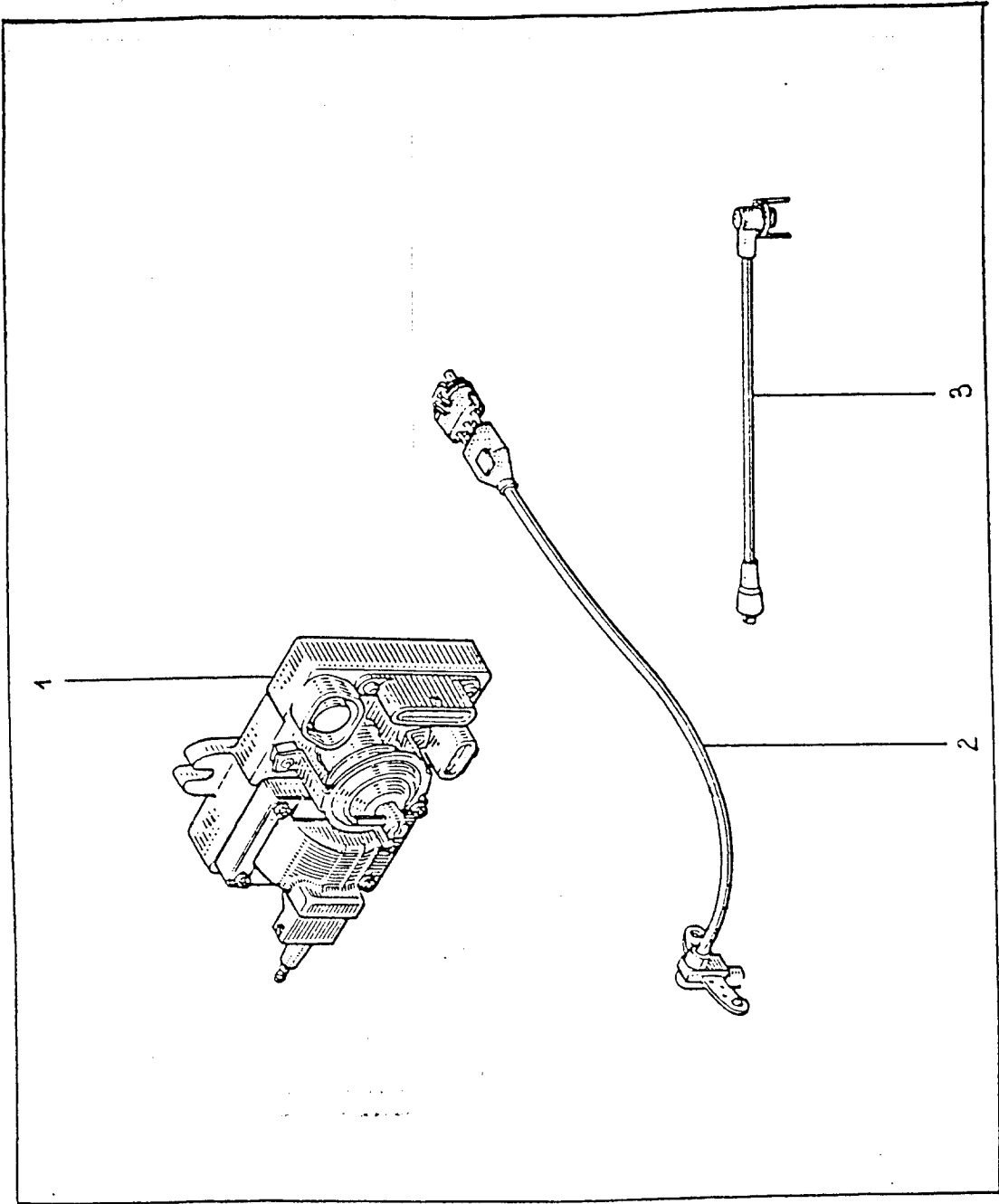

- 1 - 60 01 007 475 * Mil. 86-87
- 60 01 009 298 * Mil. 88-89-90
- 2 - 77 00 722 143
- 3 - 77 00 720 841

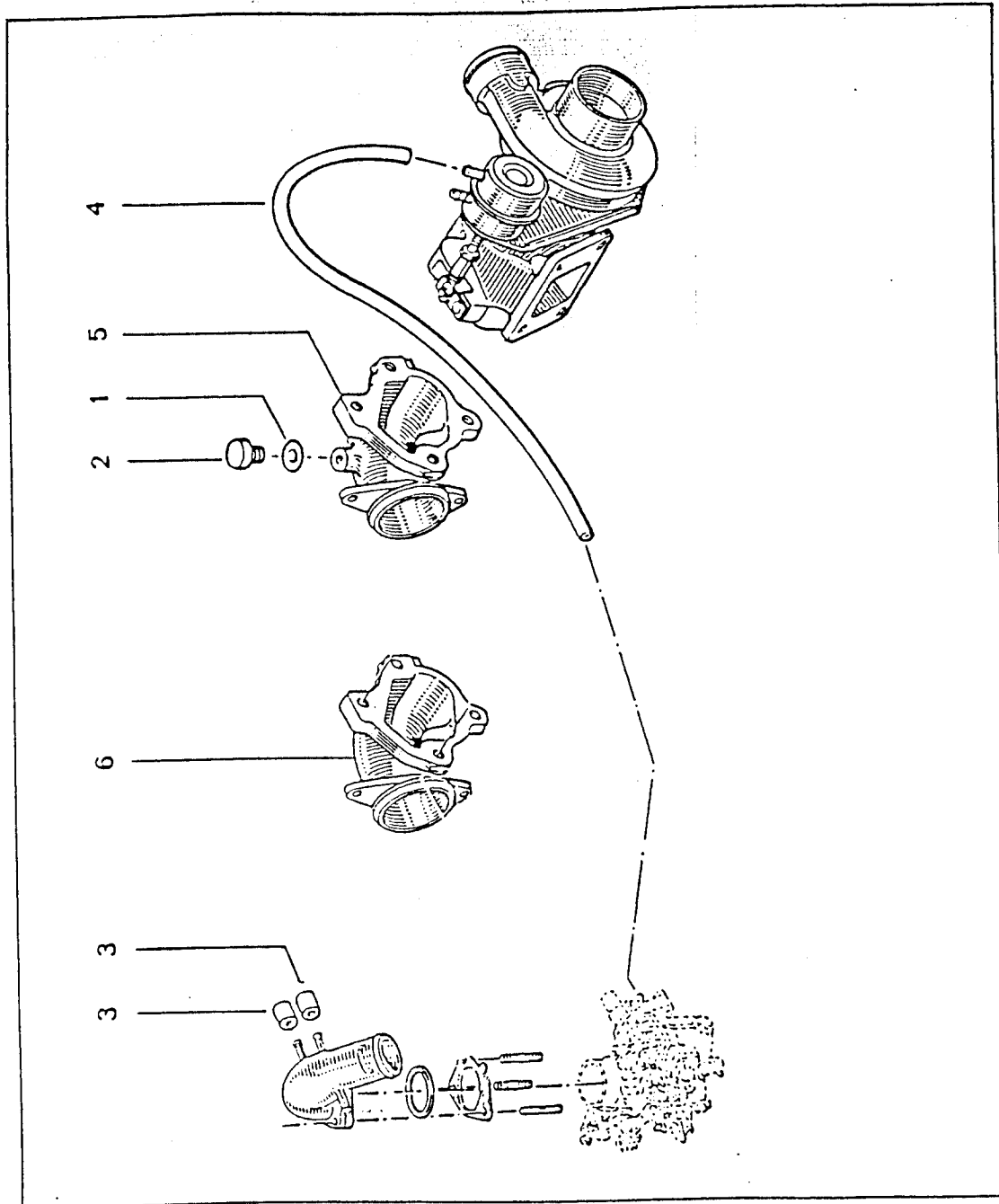
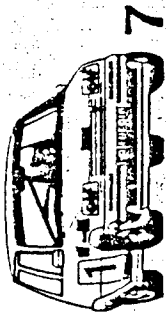

1 - 77 03 062 024

2 - 77 03 075 121

3 - 77 03 074 094

4 - 60 01 004 977 *

5 - 60 01 006 870

≠

6 - 60 01 004 015

Ref Cache Thermique :

60 01 009 529

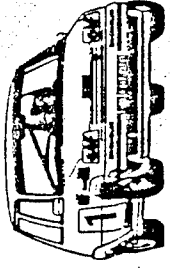

8

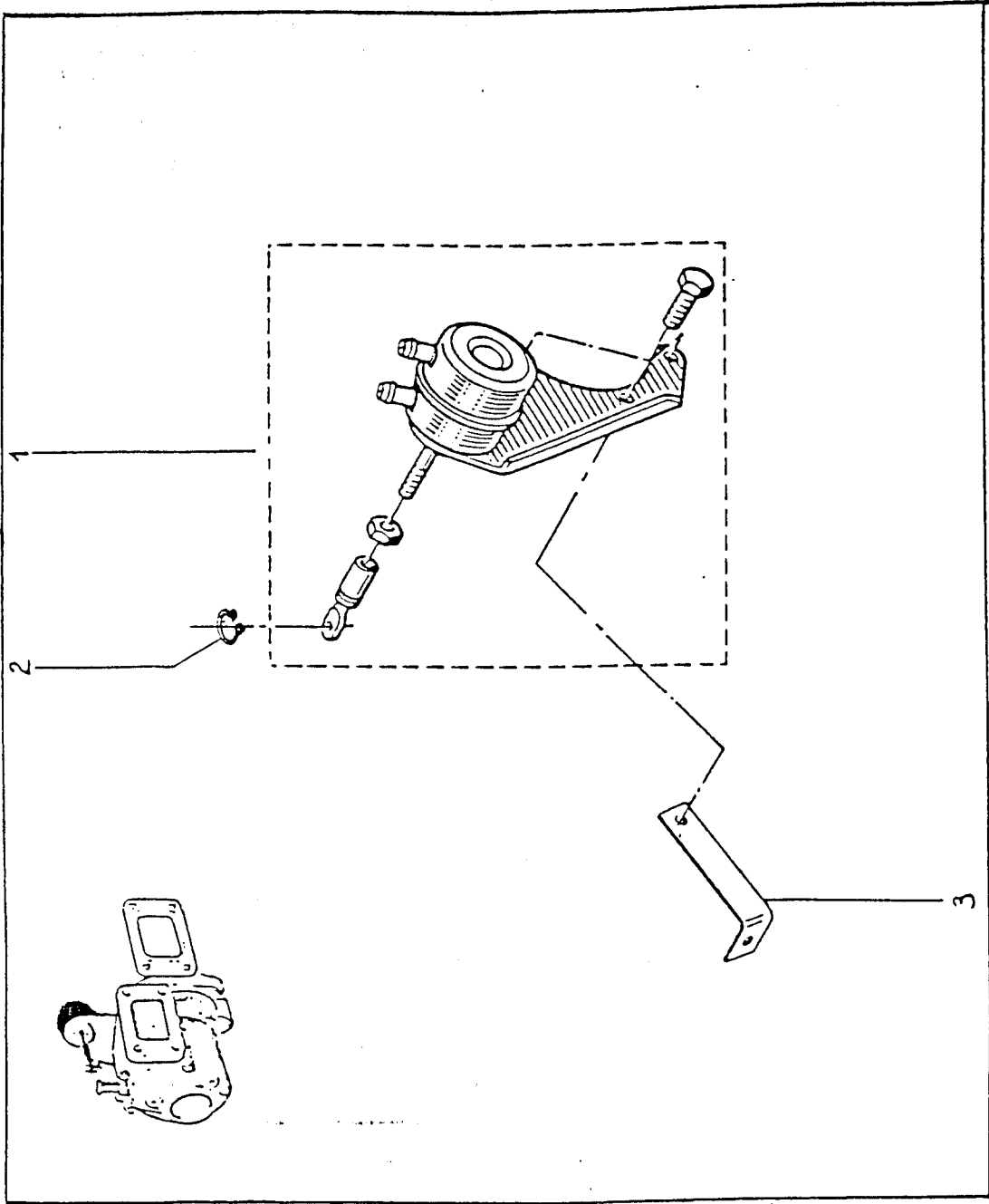

1 - 60 00 007 918 *

2 - 60 00 061 089 *

3 - 77 11 066 872 *

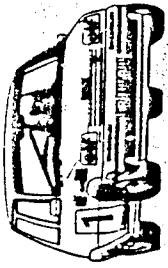

9

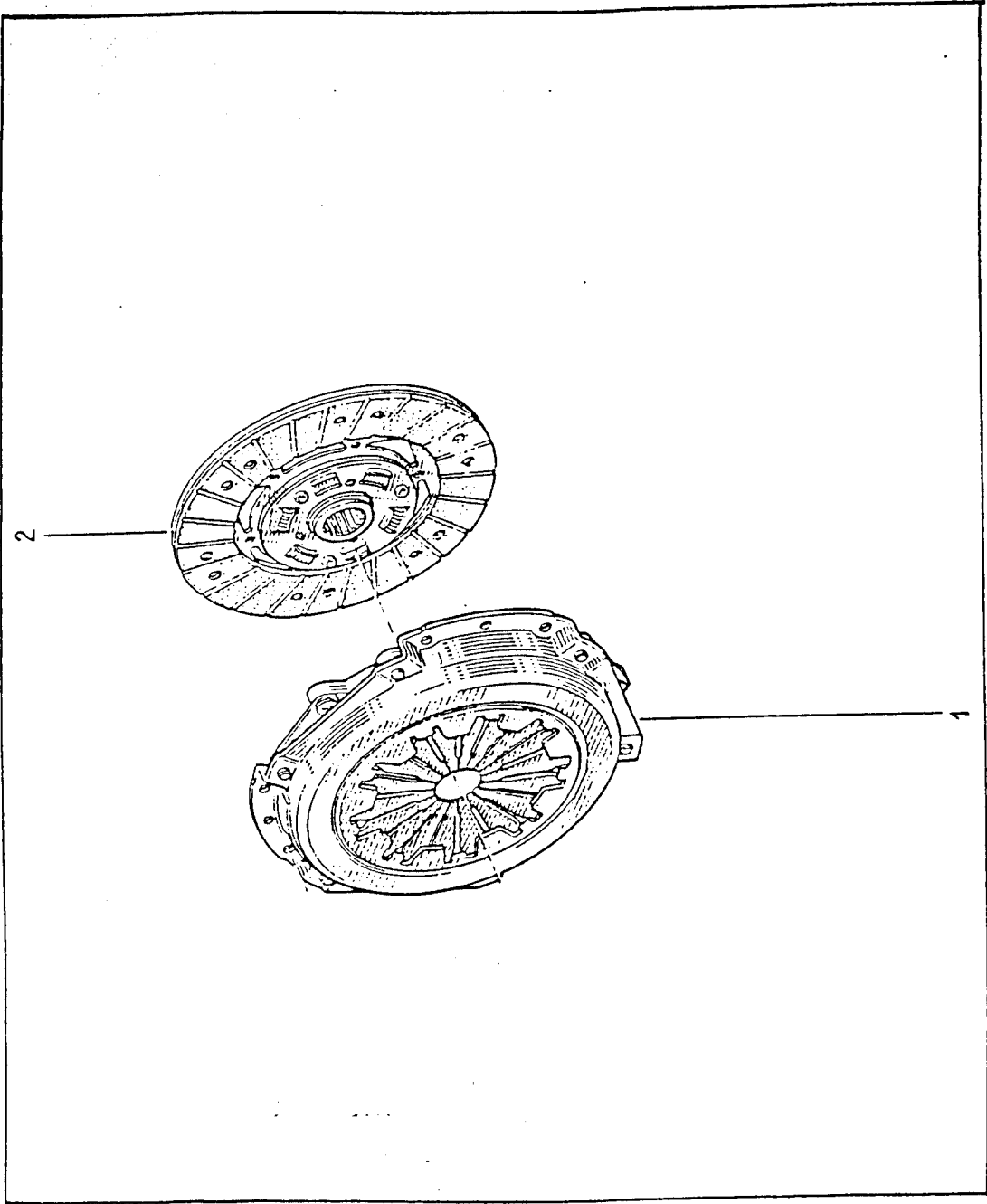

1 - 77 11 065 984 *

2 - 77 11 065 985 *

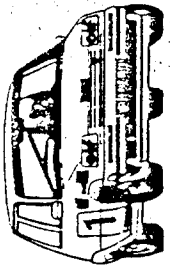

10

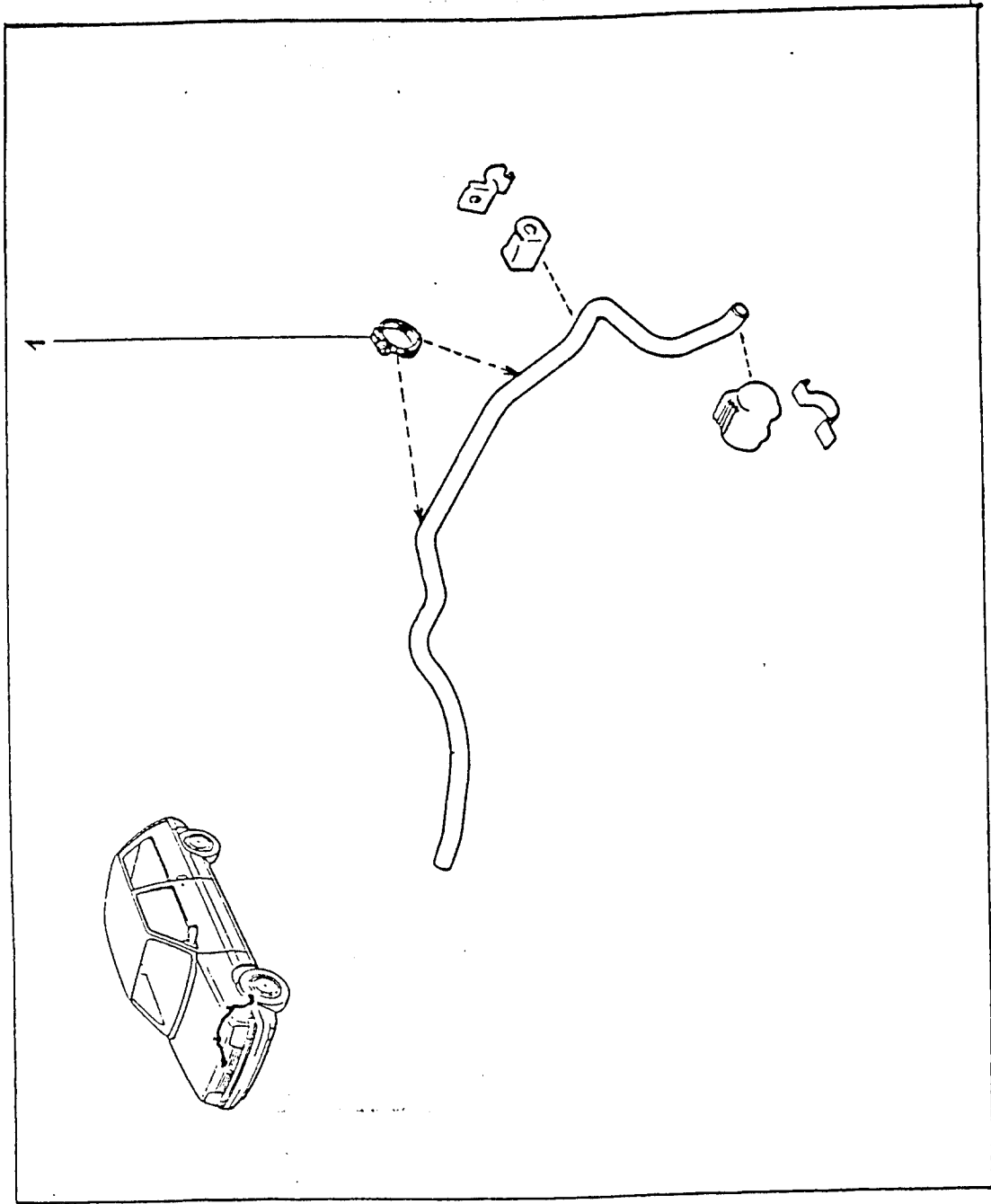

1 - 77 00 266 081

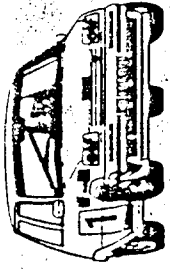

11

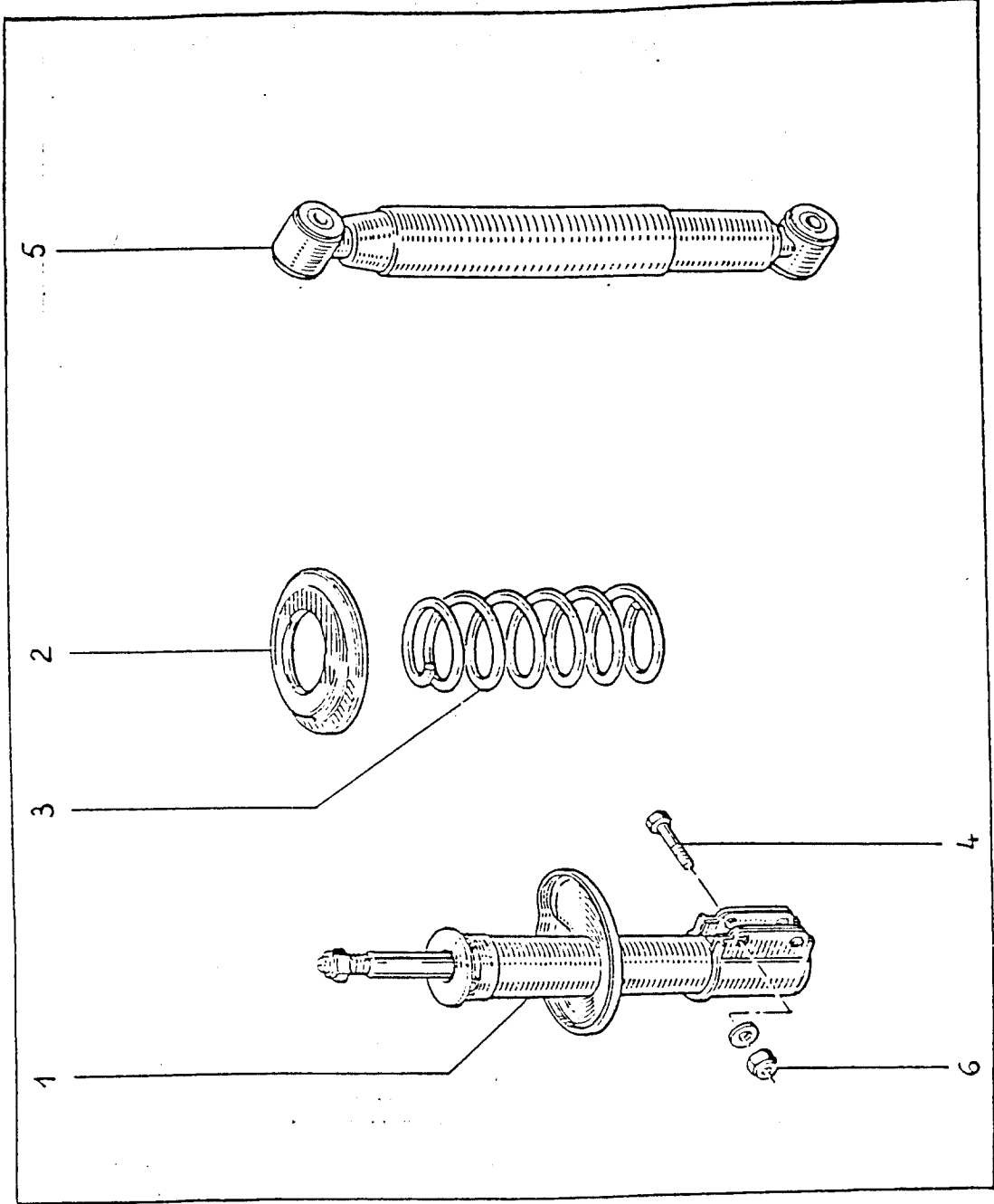

- 1 - 60 01 008 894 G * Mil 85 à 87
- 60 01 009 433 D * Mil 85 à 87
- 60 01 022 200 G * Mil 88 à 90
- 60 01 021 066 D * Mil 88 à 90
- 2 - 77 00 716 825 * Mil 85
- 77 00 769 649 Mil 86 à 90
- 3 - 60 01 007 958 * Mil 85 - 87
- 60 01 008 769 * Mil 86 - 87
- 60 01 021 063 * Mil 88 à 90
- 4 - 60 01 009 401 *
- 5 - 60 01 007 385 *
- 6 - 77 03 034 091 *

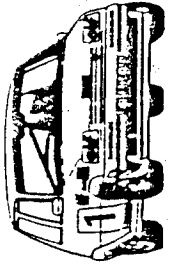

11.1

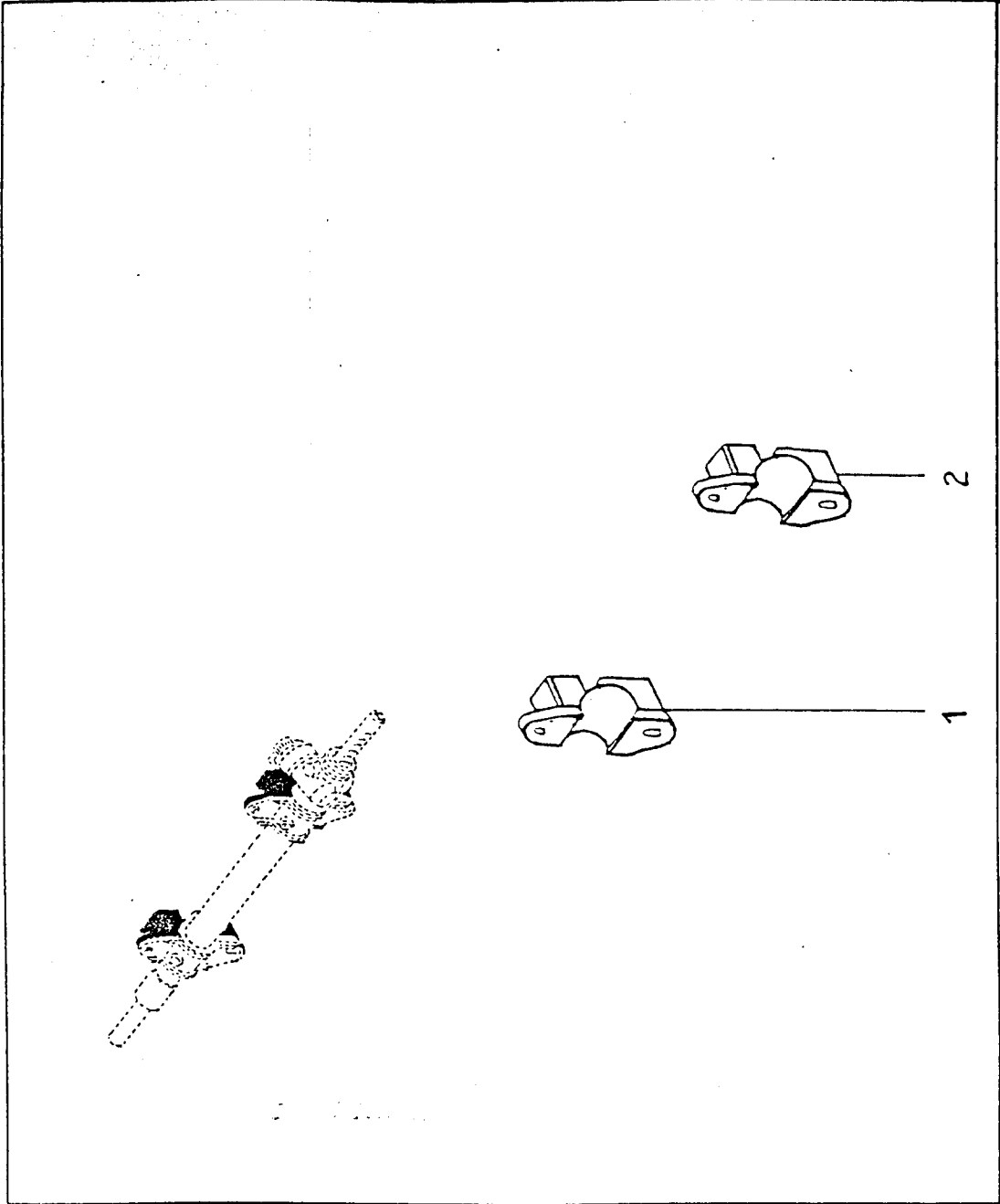

1 -60 01 007 918 * Millésime 88

2 -60 01 007 919 * Millésime 88

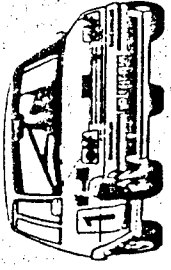

12

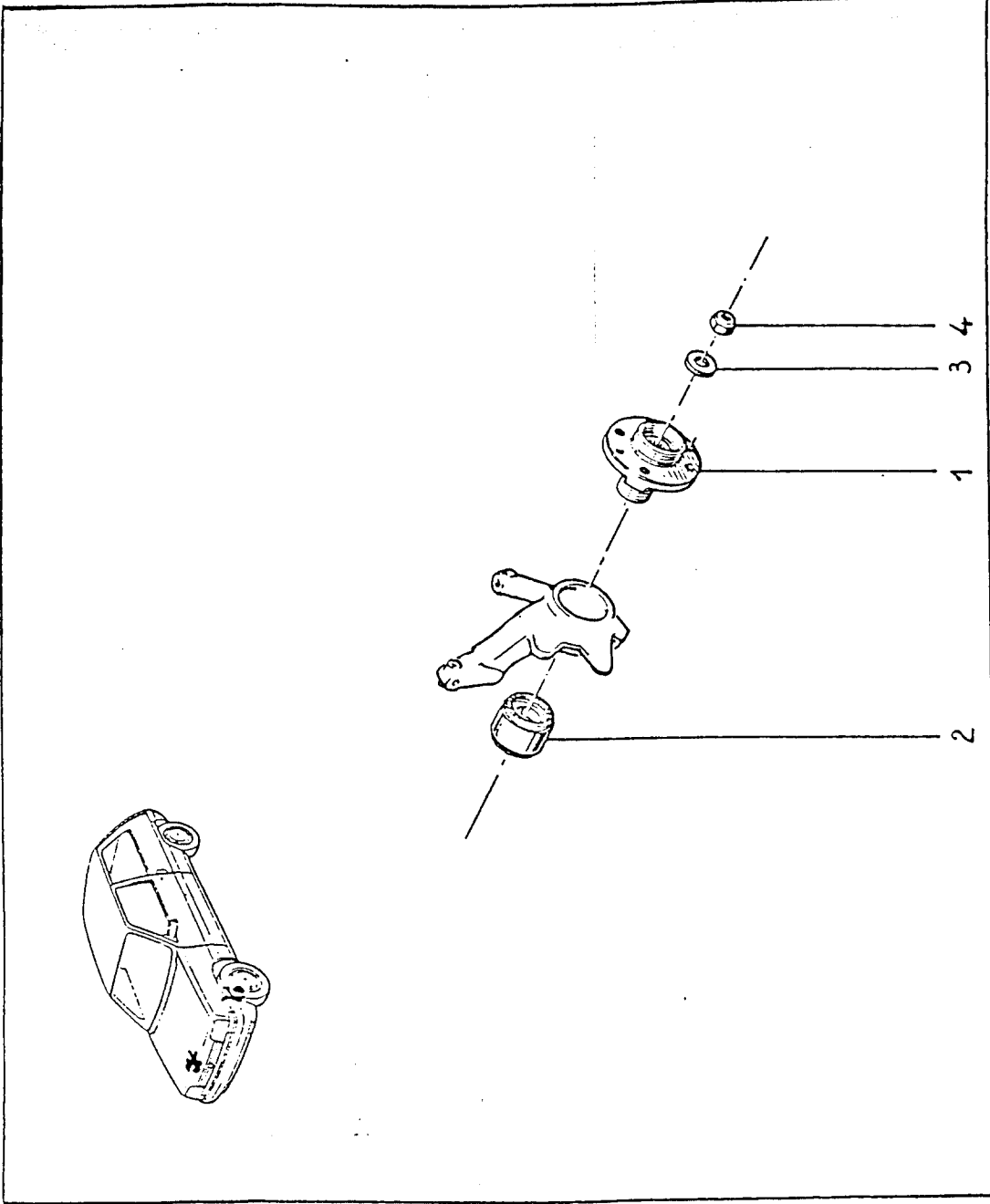

1 - 77 11 065 983 *

2 - 77 11 066 592 *

3 - 77 03 058 047 *

4 - 77 11 066 736 *

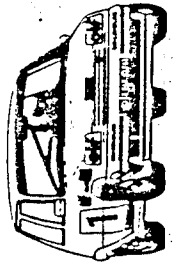

13

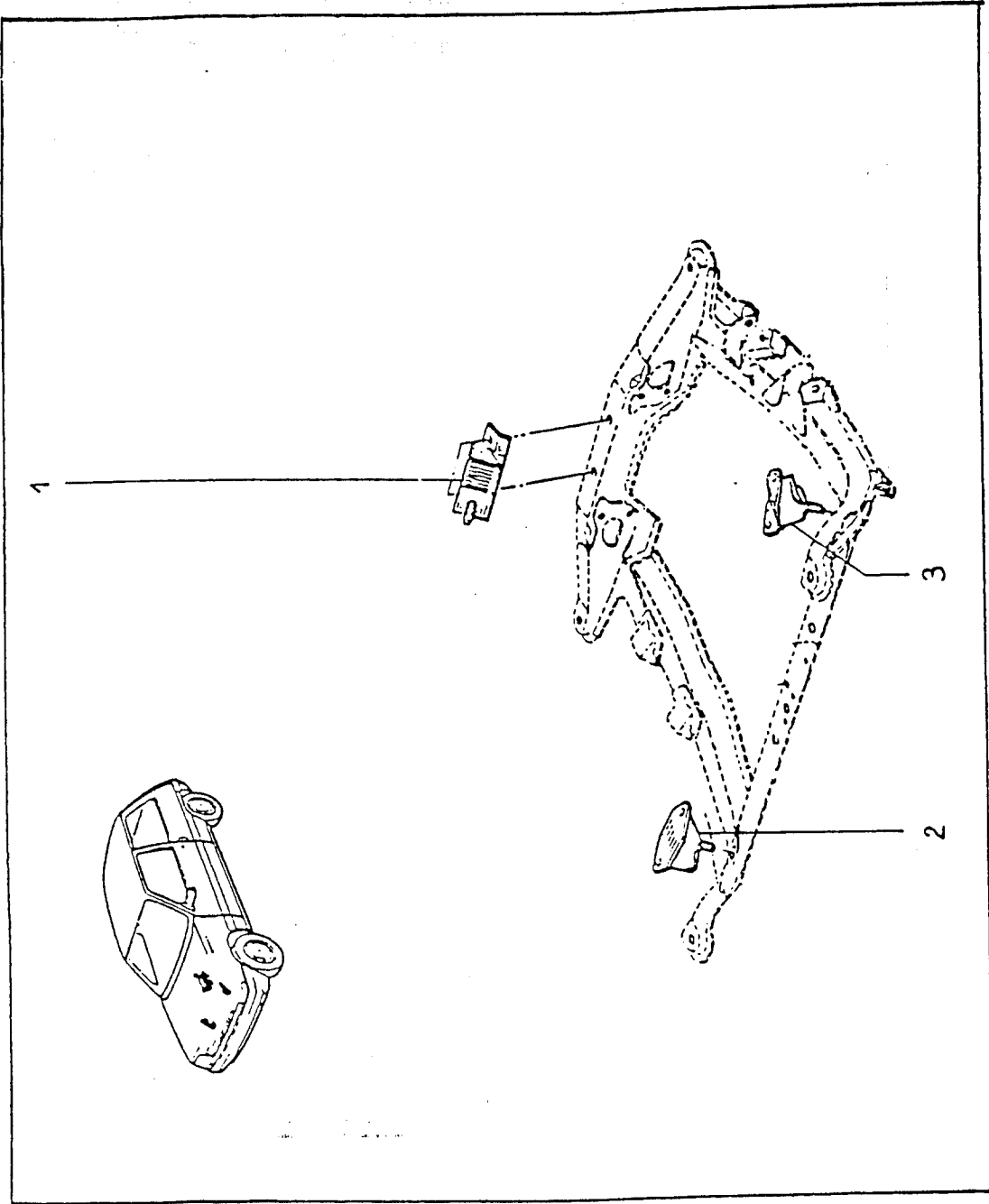

1 - 77 11 065 509 *

2 - 77 11 065 510 *

3 - 60 01 007 858 *

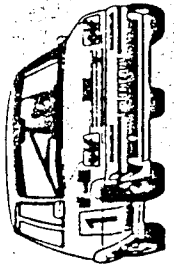

14

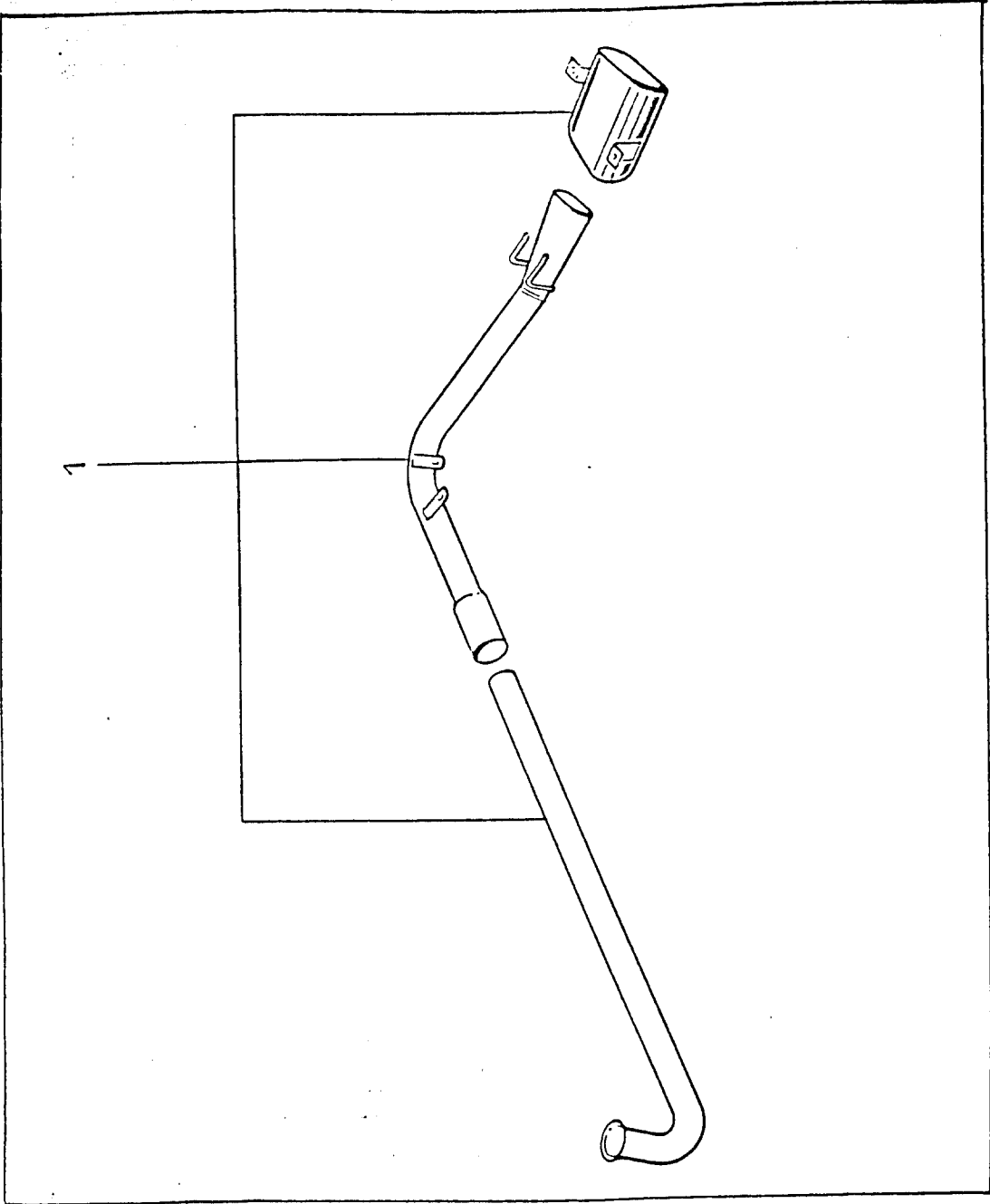

1 - 60 00 .007 917 *

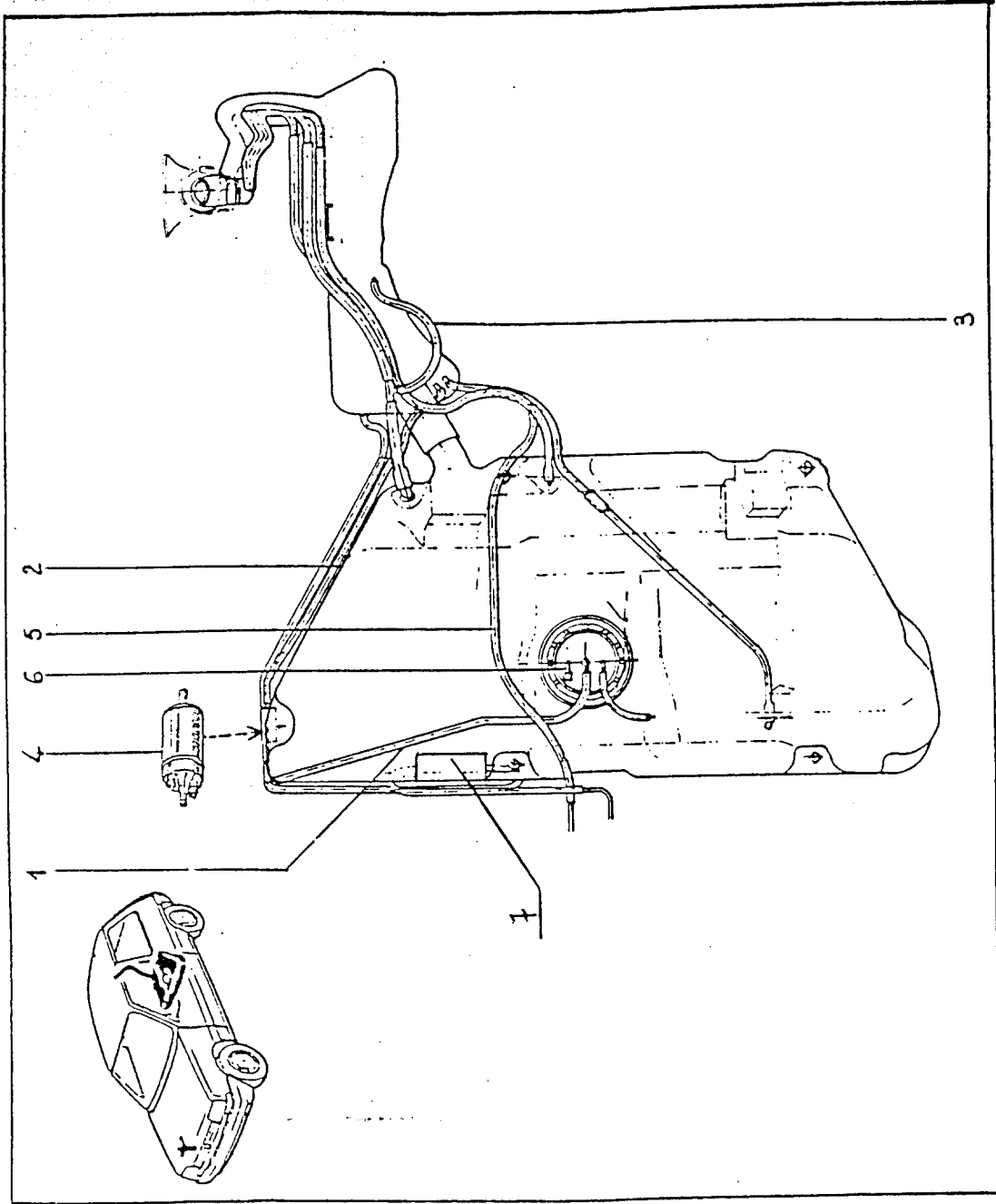
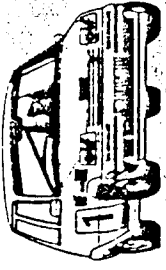

1 - 60 01 007 713 *

2 - 60 01 007 714 *

3 - 77 05 026 012

4 - 60 00 007 920 *

Mil. 89-90

60 01 008 843 *

5 - 60 01 007 712 *

6 - 77 03 074 313

7 - 60 01 023 051 *

Mil. 89-90

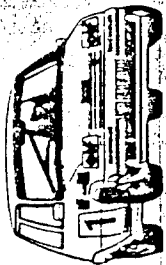

16

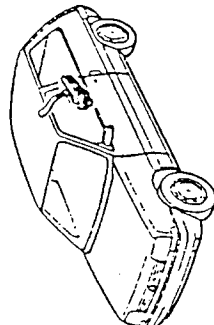
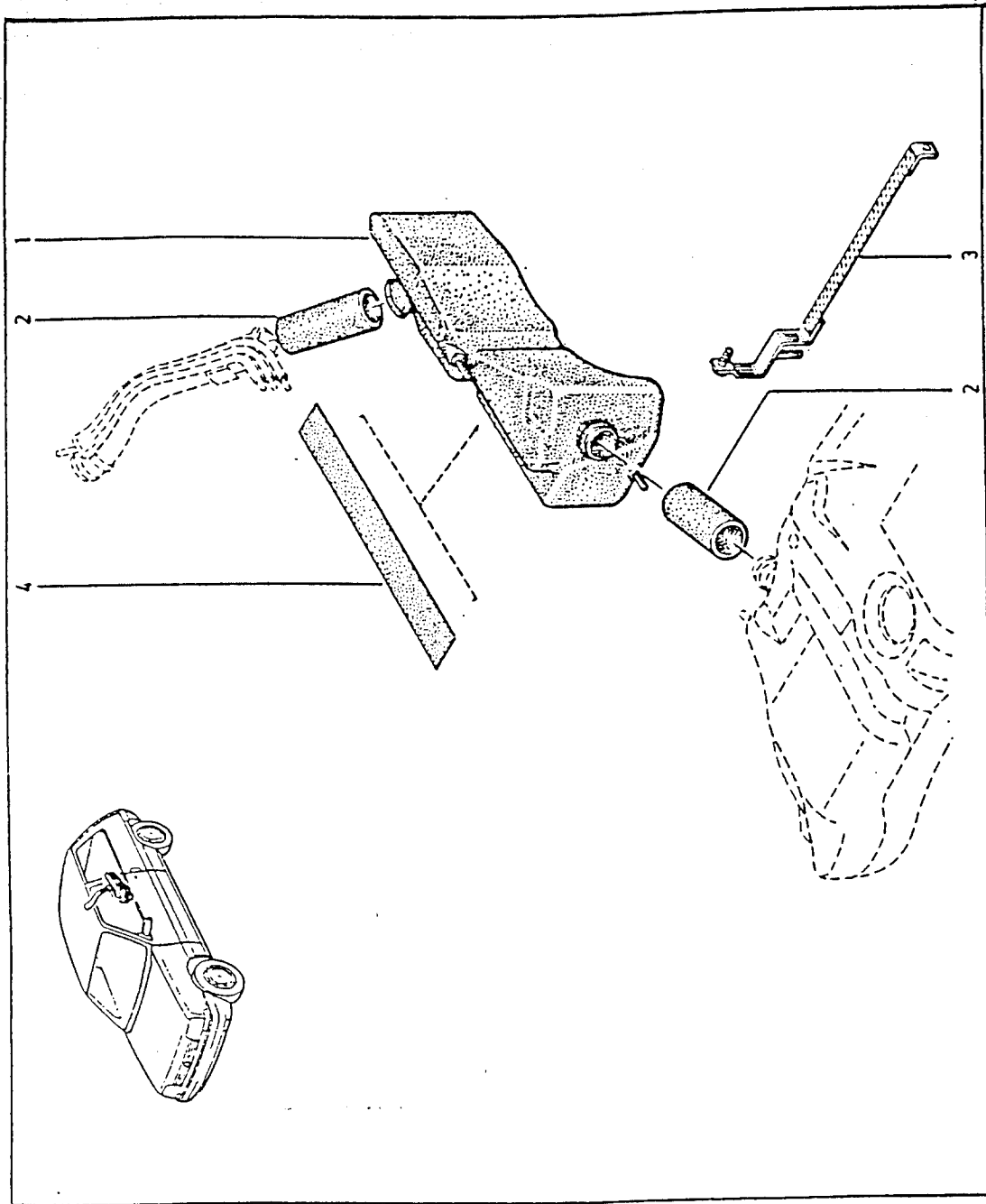

1 - 60 01 007 729 *

2 - 77 05 026 440  1m

3 - 60 01 007 154

4 - 77 00 576 366

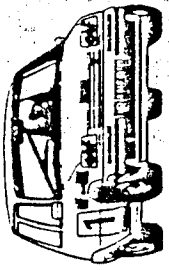

17

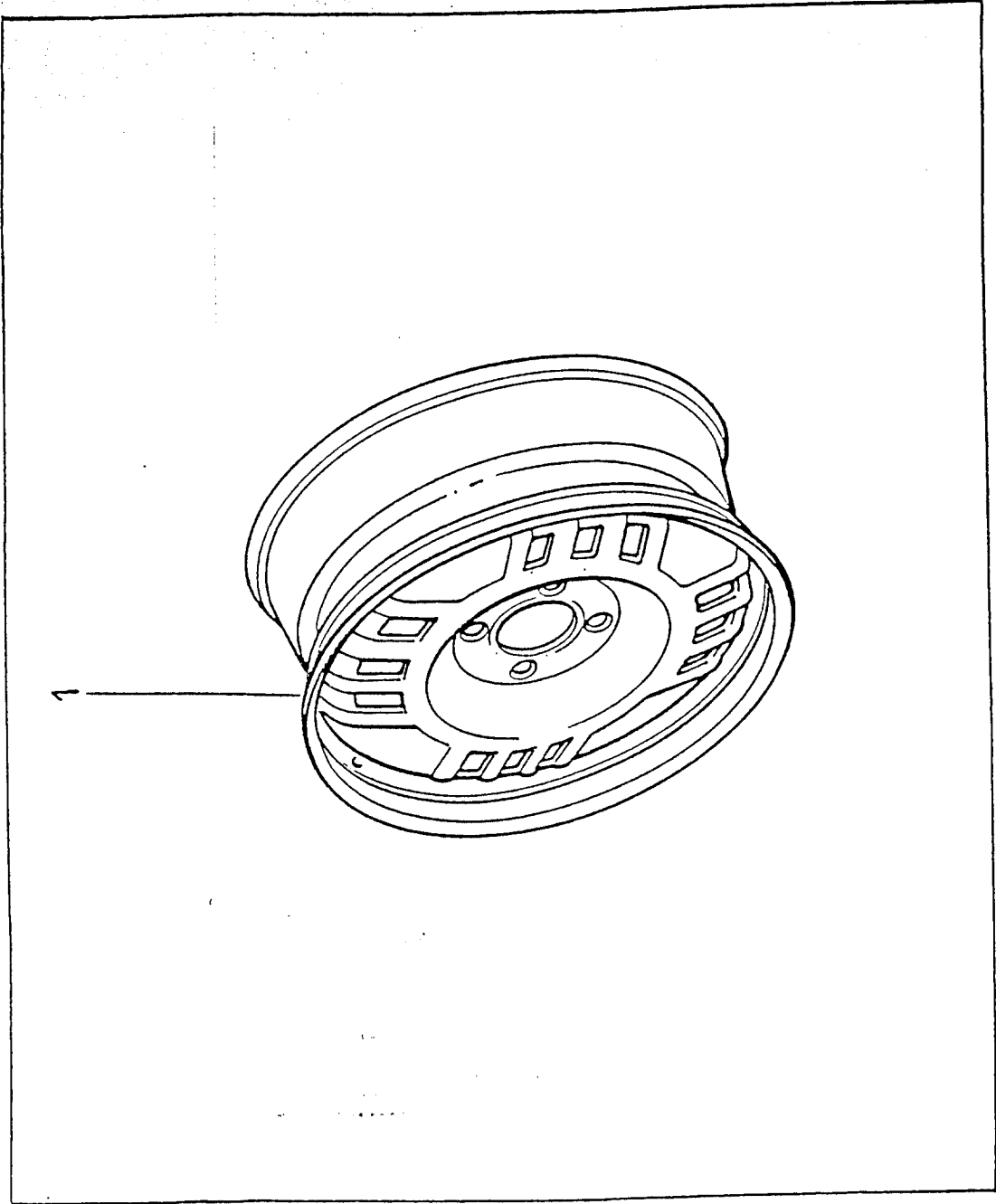

1 - 60 00 007 808 *

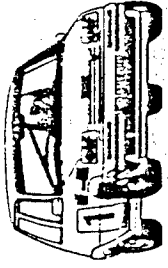

18

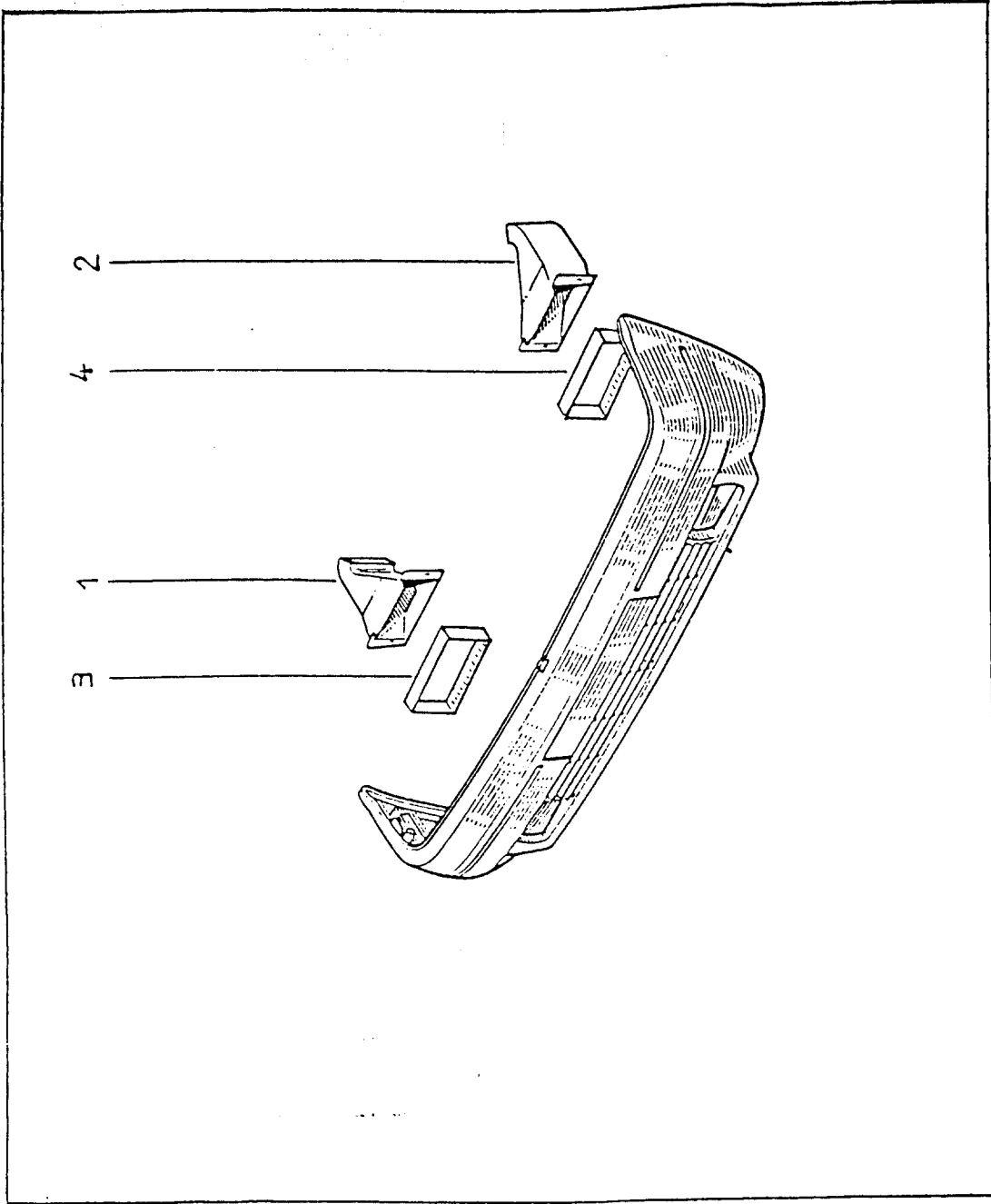

- 1 - 60 01 007 613 *
- 2 - 60 01 007 614 *
- 3 - 60 01 022 248 *
- 4 - 60 01 022 247 *

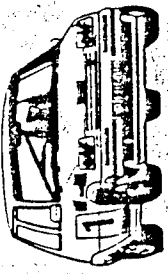

19

1 - 60 00 007 919 ACIER (DEVIL)

77 11 068 324 ACIER (MATTER)

